

Replacement Parts for Single Deck Faucets

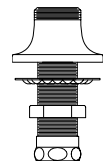

3800
SINGLE DECK
BASE
SWIVEL

10014 (24")
10022 (36")
SUPPLY LINE
1/2" F x 1/2" F

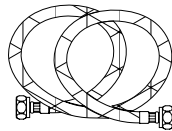

10049 (24")
10006 (36")
SUPPLY LINE
1/2" M x 1/2" F

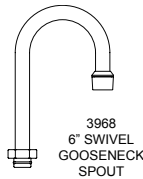
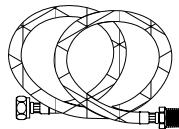

3968
6" SWIVEL
GOOSENECK
SPOUT

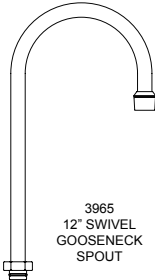

3965
12" SWIVEL
GOOSENECK
SPOUT

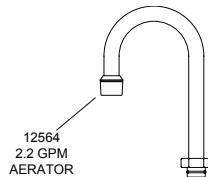

12564
2.2 GPM
AERATOR

15621
SPOUT NUT



2002
SNAP RING



1600-5000
SPOUT
O-RINGS



10456
LUBE



19119
SWIVEL SPOUT
RETRO-FIT KIT

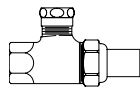

1792
ANGLE STOP
WITH KEY

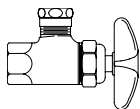

1790-1
ANGLE STOP
W/ CROSS
HANDLES

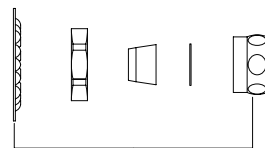

1000-8002
SLIP JOINT KIT



Single Deck Faucet Product Installation Guide

Since 1936, Fisher Manufacturing Company has manufactured heavy-duty, high quality plumbing products and hardware specialties for the food service industry. For three generations, the Fisher family has adhered to a strict dedication of and overall value. When you install Fisher products... you install the best. Our hardware is manufactured with the standardization of internal mechanisms. All chrome plating is triple plated copper, nickel and chrome for durability. Every piece of equipment we make is rigorously tested in both our modern in-house testing center and in actual field situations under extreme conditions. Every detail is thoroughly checked. Before we make our products available to you, they pass each and every test. You get proven performance. Guaranteed.

Limited One Year Warranty

Fisher Manufacturing Company warrants its products and parts thereof (except as noted below) against defects in materials or workmanship for a period of one year after the date of original purchase. During this period Fisher Manufacturing Company will replace a defective product or part without charge to you, provided that the entire product is delivered to Fisher Manufacturing Company. All transportation and insurance charges for shipping the product to and from Fisher Manufacturing Company must be borne by you. Charges for transportation and insurance may, at the option of Fisher Manufacturing Company, be refunded depending upon our investigation of the warranty claim. This warranty does not cover external finish (except at date of original purchase) or labor costs not specifically authorized by Fisher Manufacturing Company.

A full and complete copy of our One Year limited warranty is available upon request.

WARNING:

Proposition 65 requires that we provide you with the following notice: "This product Contains A Chemical Known To The State Of California To Cause Birth Defects Or Other Reproductive Harm."



#3815 - Single Deck Base: 12" Swivel Gooseneck Spout

#1929 - Single Deck Base: 6" Swivel Gooseneck Spout

KEEP THIS MANUAL FOR FUTURE REFERENCE



ANSI/A112.18.1M, ANSI/NSF 61.9

Installation Instructions for Deck Faucets

BE SURE TO CHECK WITH YOUR LOCAL DEPARTMENT HAVING JURISDICTION REGARDING BACKFLOW PREVENTION

Installation Notes:

- Be sure to shut off water supply before beginning.
- Use pipe thread sealant such as PST on all threaded joints.
- Check the packaging for missing items BEFORE beginning installation. If items are missing, contact your supplier.

Tools Required for Installation

- Medium Sized Crescent Wrench
- Pipe Thread Sealant



Package Contents

The box should contain the following:

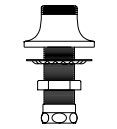

Swivel Gooseneck
Single Deck Base
Qty: 1

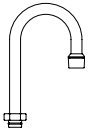

Swivel Gooseneck
Length determined by model
Qty: 1
Each spout includes one 2002 snap ring
and two 1600-5000 o-rings

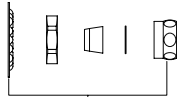

1000-8002
Slip Joint Kit
Qty: 1



10456
Lube

Installation Instructions

1. Mount single deck base on deck by inserting the nipple through a pre-drilled 7/8" hole in deck. Apply thread sealant to the nipple and attach slip joint kit. Tighten until control valve is secure.
2. Apply o-ring lube to the o-rings on the swivel gooseneck spout. Make sure the white snap ring is in place before mounting the swivel gooseneck spout. Mount the swivel gooseneck spout and tighten the swivel gooseneck spout nut onto the single deck base.
3. Turn on water supply and check for leaks.

Step 1

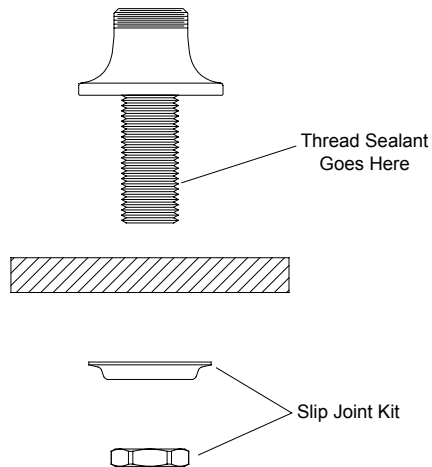

Installation Instructions Continued

Step 2

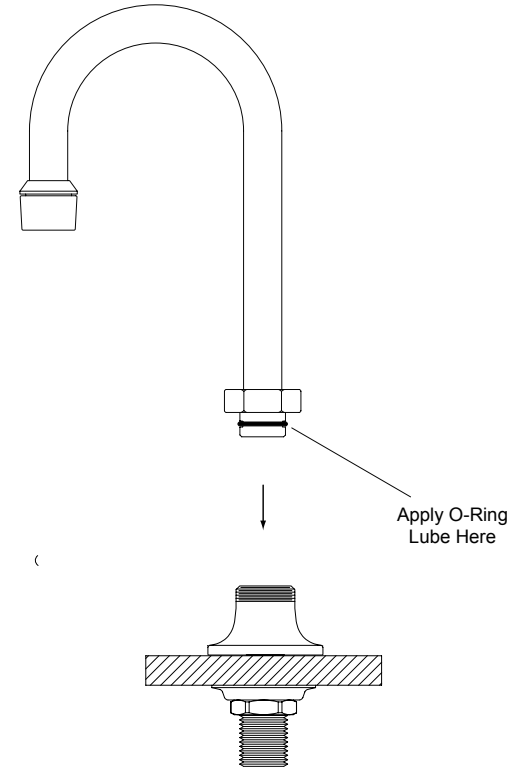

Step 3

