

Replacement Parts for Wall Mount Faucets

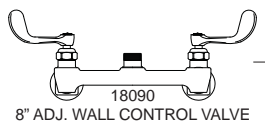

18090
8" ADJ. WALL CONTROL VALVE

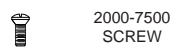

2000-7500
SCREW

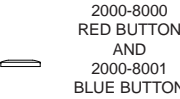

2000-8000
RED BUTTON
AND
2000-8001
BLUE BUTTON

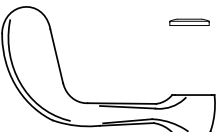

3984-2300
WRIST HANDLE



2000-3002
BIBB CAP



10464
DUCK GASKET



2000-5000
WASHER

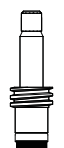

3000-0010
LH SWIVEL STEM
OR
3000-0011
RH SWIVEL STEM



16101
FLAT SEAT
WASHER



1000-7502
SCREW



10456
LUBE



3200-2306
ECCENTRIC
FLANGES



3200-2307
1/2" ECCENTRICS



2200-5000
ECCENTRIC GASKETS

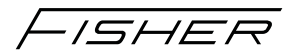

MANUFACTURING COMPANY
PO BOX 60, TULARE, CA 93275
(800)421-6162, FAX: (800)832-8238
www.fisher-mfg.com

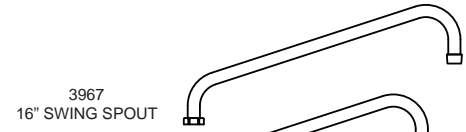

3967
16" SWING SPOUT



3964
14" SWING SPOUT



3963
12" SWING SPOUT



3962
10" SWING SPOUT



3961
8" SWING SPOUT



3960
6" SWING SPOUT

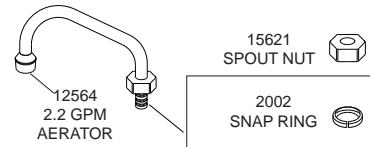

12564
2.2 GPM
AERATOR

15621
SPOUT NUT



2002
SNAP RING



1600-5000
SPOUT
O-RING



10456
LUBE

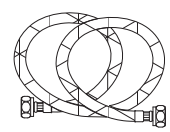

10014 (24")
10022 (36")
SUPPLY LINE
1/2" F X 1/2" F

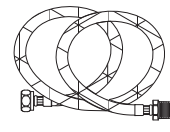

10049 (24")
10006 (36")
SUPPLY LINE
1/2" M X 1/2" F

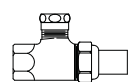

1792
ANGLE STOP
WITH KEY

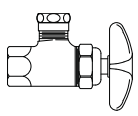

1790-1
ANGLE STOP
WITH CROSS
HANDLES

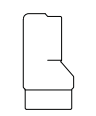

2400-2103
ELBOWS

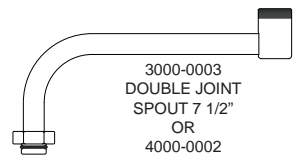

3000-0003
DOUBLE JOINT
SPOUT 7 1/2"
OR
4000-0002
DOUBLE JOINT
SPOUT 14"

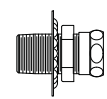

2200-0000
SLIP JOINT KIT



8" Adjustable Wall Mount Faucet Product Installation Guide

Since 1936, Fisher Manufacturing Company has manufactured heavy-duty, high quality plumbing products and hardware specialties for the food service industry. For three generations, the Fisher family has adhered to a strict dedication of and overall value. When you install Fisher products... you install the best. Our hardware is manufactured with the standardization of internal mechanisms. All chrome plating is triple plated copper, nickel and chrome for durability. Every piece of equipment we make is rigorously tested in both our modern in-house testing center and in actual field situations under extreme conditions. Every detail is thoroughly checked. Before we make our products available to you, they pass each and every test. You get proven performance. Guaranteed.

Limited One Year Warranty

Fisher Manufacturing Company warrants its products and parts thereof (except as noted below) against defects in materials or workmanship for a period of one year after the date of original purchase. During this period Fisher Manufacturing Company will replace a defective product or part without charge to you, provided that the entire product is delivered to Fisher Manufacturing Company. All transportation and insurance charges for shipping the product to and from Fisher Manufacturing Company must be borne by you. Charges for transportation and insurance may, at the option of Fisher Manufacturing Company, be refunded depending upon our investigation of the warranty claim. This warranty does not cover external finish (except at date of original purchase) or labor costs not specifically authorized by Fisher Manufacturing Company.

A full and complete copy of our One Year limited warranty is available upon request.

WARNING:

Proposition 65 requires that we provide you with the following notice: "This product Contains A Chemical Known To The State Of California To Cause Birth Defects Or Other Reproductive Harm."



- #48739 - 8" Adj. Wall Mount Faucet with 6" Swing Spout 7" DJ Swing Spout
- #48747 - 8" Adj. Wall Mount Faucet with 8" Swing Spout 7" DJ Swing Spout
- #48755 - 8" Adj. Wall Mount Faucet with 10" Swing Spout 7" DJ Swing Spout
- #48763 - 8" Adj. Wall Mount Faucet with 12" Swing Spout 7" DJ Swing Spout
- #48771 - 8" Adj. Wall Mount Faucet with 14" Swing Spout 7" DJ Swing Spout
- #48798 - 8" Adj. Wall Mount Faucet with 16" Swing Spout 7" DJ Swing Spout



ANSI/A112.18.1M, ANSI/NSF 61.9

FISHER MANUFACTURING COMPANY, TOLL FREE: 800-421-6162, FAX: 800-832-8238

www.fisher-mfg.com

Installation Instructions for Wall Mount Faucet

BE SURE TO CHECK WITH YOUR LOCAL DEPARTMENT HAVING JURISDICTION REGARDING BACKFLOW PREVENTION.

Installation Notes:

- Be sure water supply is shut-off before beginning.
- Use pipe thread sealant on all threaded joints such as PST or Teflon tape.
- Check the packaging for missing items BEFORE beginning installation. If items are missing, contact your supplier.

Package Contents

The box should contain the following:

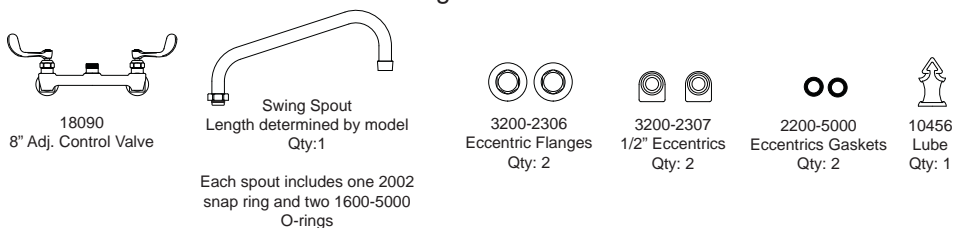

Items needed for Installation

- 1 - Medium Sized Crescent Wrenches
- 1 - Plumbers Tape or Pipe Thread Sealant



Installation Instructions

Step 1.

After unpacking items and checking for missing components, insert and center the gasket into the female swivel inlets of the 8" control valve body. Loosely mount the eccentrics and flange onto the control valve body.

Step 2.

Mount control valve body to either a wall with a male supply nipples, or backsplash with nipples (not included). Be sure to use pipe thread sealant on the supply nipple threads. Adjust the eccentrics as needed in order to mount the control valve level. Once level, tighten the eccentrics

Step 3.

Optional DJ swivel spout, apply lube to the O-ring on the spout. Mount the DJ swivel spout and tighten the nut onto the faucet spout outlet.

Step 4.

Apply O-ring lube to the O-rings on the swing spout. Make sure the white snap ring is in place before mounting the swing spout. Mount the swing spout and tighten the swing spout nut onto the faucet spout outlet.

Step 5.

Turn on water supply and check for leaks.

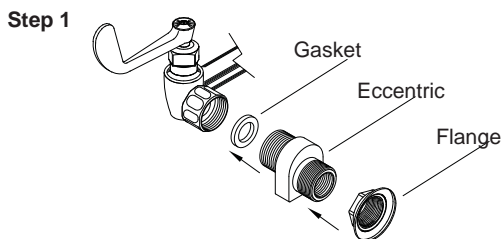

Installation Instructions Continued

Step 2

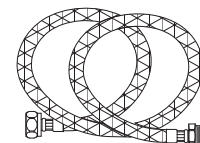
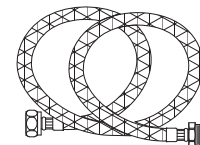
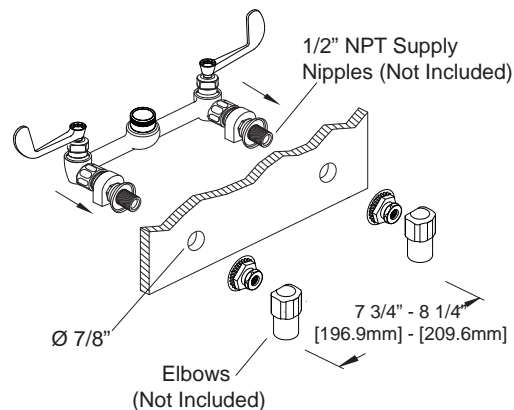
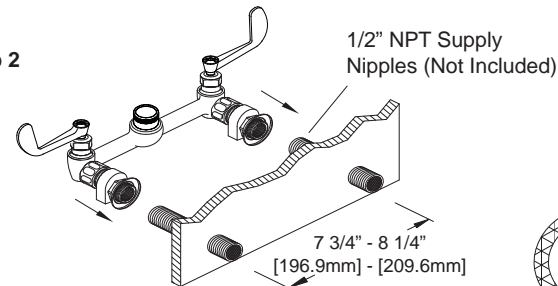

Supply Lines (Not Included)

Step 3

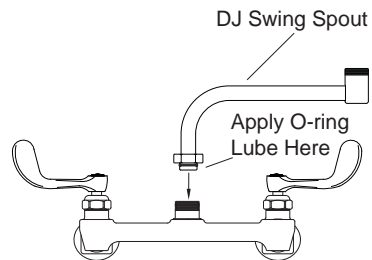

Step 4

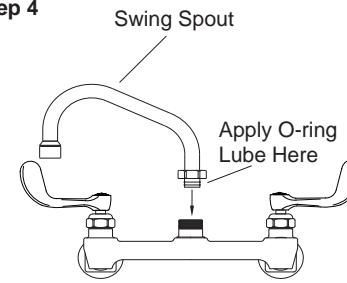

Step 5

