

# Replacement Parts for Backsplash Faucets

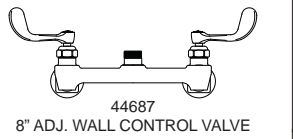

44687  
8" ADJ. WALL CONTROL VALVE

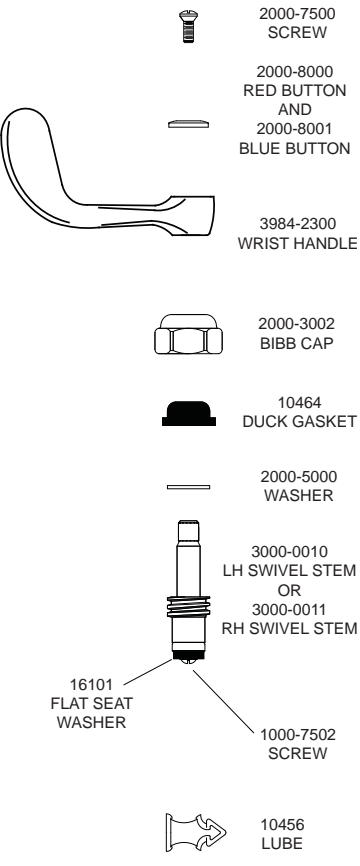

2000-7500  
SCREW

2000-8000  
RED BUTTON  
AND  
2000-8001  
BLUE BUTTON

3984-2300  
WRIST HANDLE

2000-3002  
BIBB CAP

10464  
DUCK GASKET

2000-5000  
WASHER

3000-0010  
LH SWIVEL STEM  
OR  
3000-0011  
RH SWIVEL STEM

16101  
FLAT SEAT  
WASHER

1000-7502  
SCREW

10456  
LUBE

89621  
RH SWIVEL STEM  
REPAIR KIT  
OR  
89613  
LH SWIVEL STEM  
REPAIR KIT

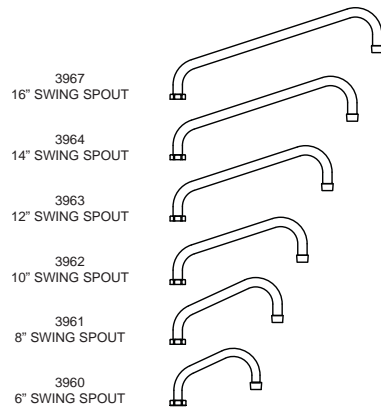

3967  
16" SWING SPOUT

3964  
14" SWING SPOUT

3963  
12" SWING SPOUT

3962  
10" SWING SPOUT

3961  
8" SWING SPOUT

3960  
6" SWING SPOUT

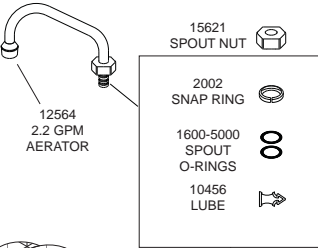

12564  
2.2 GPM  
AERATOR

15621  
SPOUT NUT

2002  
SNAP RING

1600-5000  
SPOUT  
O-RINGS

10456  
LUBE

19119  
SWIVEL SPOUT  
RETRO-FIT KIT

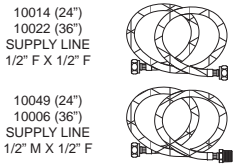

10014 (24")  
10022 (36")  
SUPPLY LINE  
1/2" F X 1/2" F

10049 (24")  
10006 (36")  
SUPPLY LINE  
1/2" M X 1/2" F

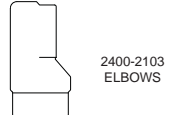

2400-2103  
ELBOWS

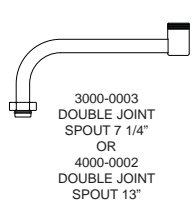

3000-0003  
DOUBLE JOINT  
SPOUT 7 1/4"  
OR  
4000-0002  
DOUBLE JOINT  
SPOUT 13"

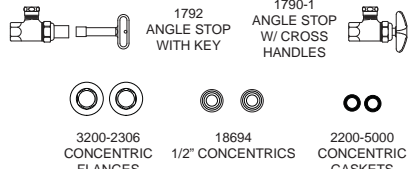

1792  
ANGLE STOP  
WITH KEY

1790-1  
ANGLE STOP  
W/ CROSS  
HANDLES

3200-2306  
CONCENTRIC  
FLANGES

18694  
1/2" CONCENTRICS

2200-5000  
CONCENTRIC  
GASKETS

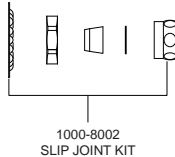

1000-8002  
SLIP JOINT KIT



## 8" C/C Backsplash Faucet Product Installation Guide

Since 1936, Fisher Manufacturing Company has manufactured heavy-duty, high quality plumbing products and hardware specialties for the food service industry. For three generations, the Fisher family has adhered to a strict dedication of and overall value. When you install Fisher products... you install the best. Our hardware is manufactured with the standardization of internal mechanisms. All chrome plating is triple plated copper, nickel and chrome for durability. Every piece of equipment we make is rigorously tested in both our modern in-house testing center and in actual field situations under extreme conditions. Every detail is thoroughly checked. Before we make our products available to you, they pass each and every test. You get proven performance. Guaranteed.

### Limited One Year Warranty

Fisher Manufacturing Company warrants its products and parts thereof (except as noted below) against defects in materials or workmanship for a period of one year after the date of original purchase. During this period Fisher Manufacturing Company will replace a defective product or part without charge to you, provided that the entire product is delivered to Fisher Manufacturing Company. All transportation and insurance charges for shipping the product to and from Fisher Manufacturing Company must be borne by you. Charges for transportation and insurance may, at the option of Fisher Manufacturing Company, be refunded depending upon our investigation of the warranty claim. This warranty does not cover external finish (except at date of original purchase) or labor costs not specifically authorized by Fisher Manufacturing Company.

A full and complete copy of our One Year limited warranty is available upon request.

### WARNING:

Proposition 65 requires that we provide you with the following notice: "This product Contains A Chemical Known To The State Of California To Cause Birth Defects Or Other Reproductive Harm."



- #48801 - 8" c/c Backsplash Faucet with 6" Swing Spout
- #48828 - 8" c/c Backsplash Faucet with 8" Swing Spout
- #48836 - 8" c/c Backsplash Faucet with 10" Swing Spout
- #48844 - 8" c/c Backsplash Faucet with 12" Swing Spout
- #48852 - 8" c/c Backsplash Faucet with 14" Swing Spout
- #48860 - 8" c/c Backsplash Faucet with 16" Swing Spout

KEEP THIS MANUAL FOR FUTURE REFERENCE



ANSI/A112.18.1M, ANSI/NSF 61.9

FISHER MANUFACTURING COMPANY - TOLL FREE: 800-421-6162 FAX: 800-832-8238

# Installation Instructions for Backsplash Faucets

BE SURE TO CHECK WITH YOUR LOCAL DEPARTMENT HAVING JURISDICTION REGARDING BACKFLOW PREVENTION

## Installation Notes:

- Be sure to shut off water supply before beginning.
- Use pipe thread sealant such as PST on all threaded joints.
- Check the packaging for missing items BEFORE beginning installation. If items are missing, contact your supplier.

## Tools Required for Installation

- Medium Sized Crescent Wrench
- Pipe Thread Sealant



## Package Contents

The box should contain the following:

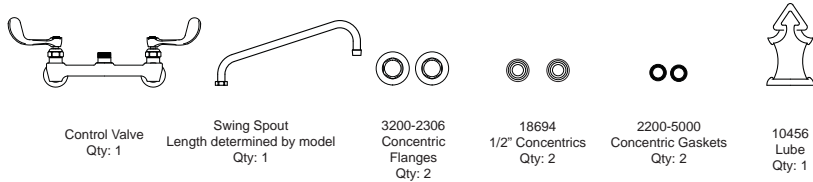

## Installation Instructions

1. After unpacking items and checking for missing components, insert the gasket into the groove on the concentric. Making sure gasket is in place, loosely mount the concentric and flange onto the control valve body.
2. Mount control valve body to the backsplash by inserting the concentrics through the backsplash and attaching slip joints. Tighten concentrics and attach elbows and supply lines (not included) as required. Be sure to use pipe thread sealant on all threads.
3. Optional DJ swivel spout, apply lube to the o-ring on the spout. Mount the DJ swivel spout and tighten the nut onto the faucet spout outlet.
4. Apply lube to the o-rings on the swing spout. Make sure the white snap ring is in place before mounting the swing spout. Mount the swing spout and tighten the swing spout nut onto the faucet spout outlet.
4. Turn on water supply and check for leaks.

### Step 1

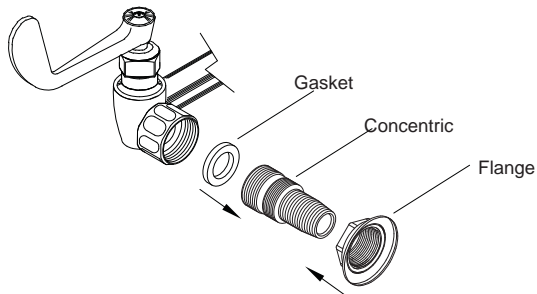

# Installation Instructions Continued

### Step 2

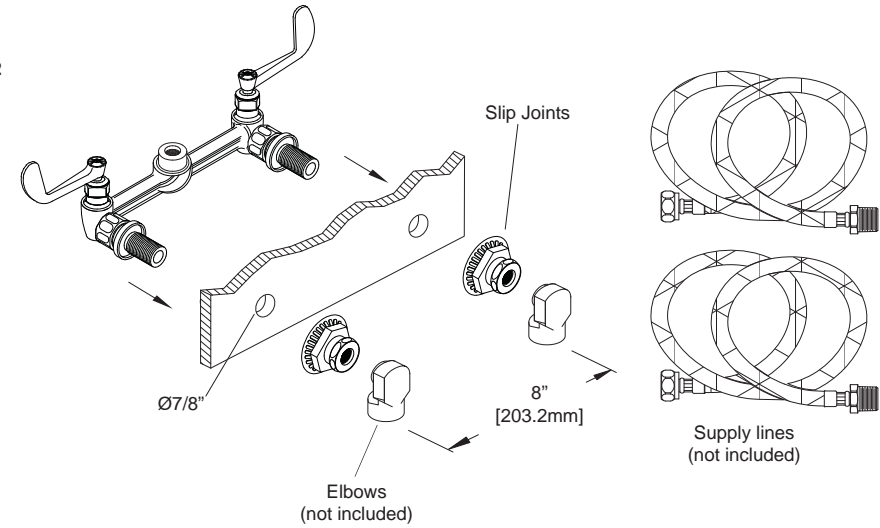

### Step 3

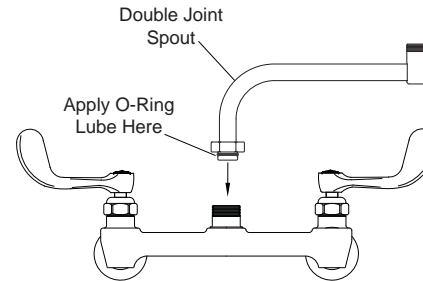

### Step 4

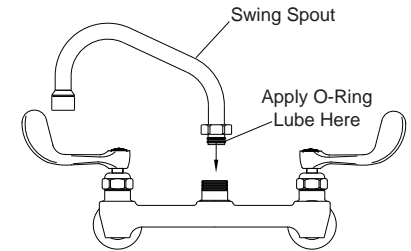

### Step 5

